

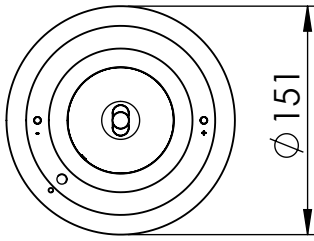

## TH rund

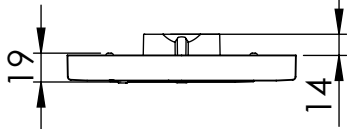

Einbau in Unterputzdose



Einbau in TH Gehäuse



Deckenausschnitt für Einbaudose z.B.

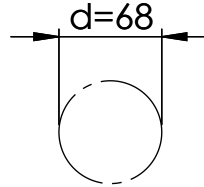

## TH eckig

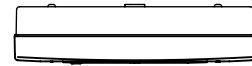
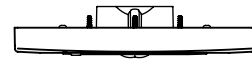
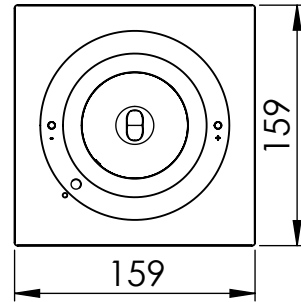

## TH Wandleuchte

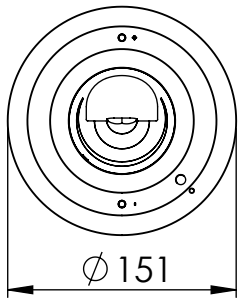

Einbau

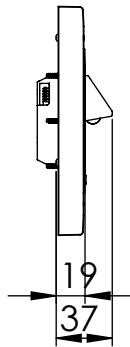

Aufbau

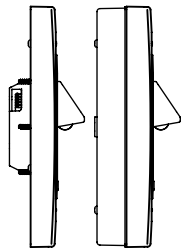
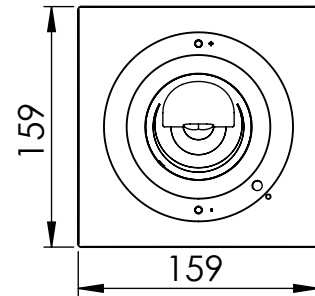
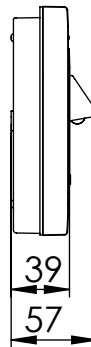

## TH rund Deckenbündig

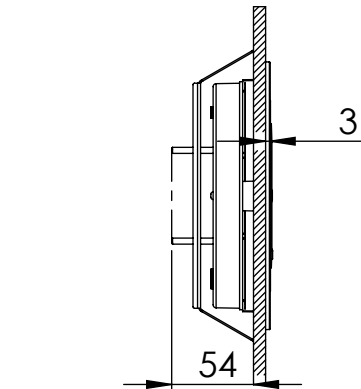
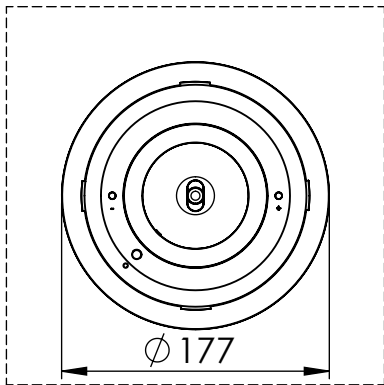

Deckenausschnitt für TH Gehäuse

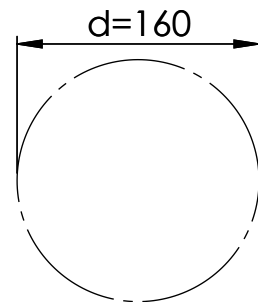

## TH Kabeleinführungen, Bohrmaße

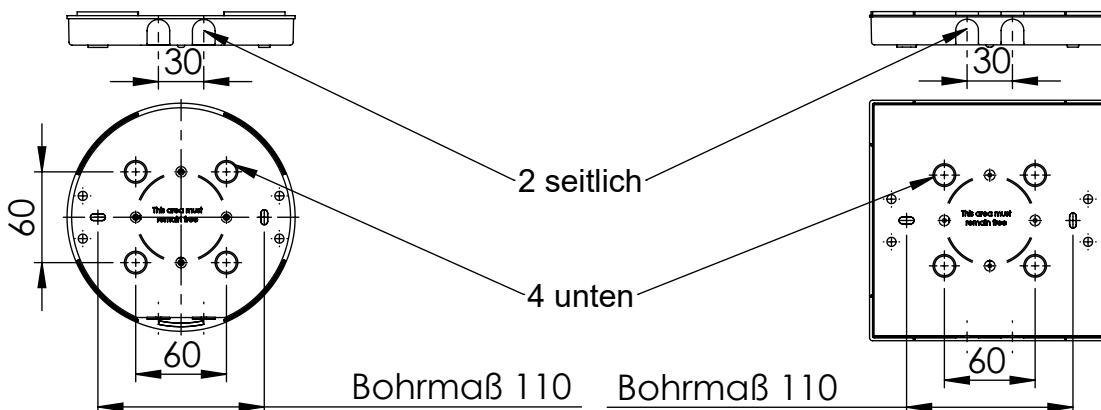



## TH4 / TH6 / TH8

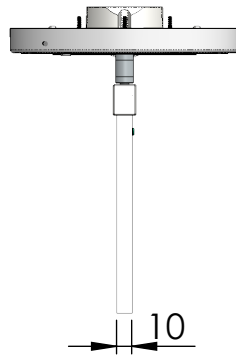
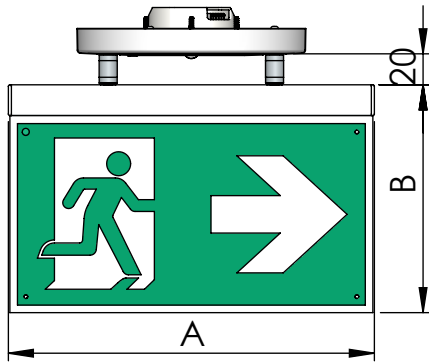

## TH Haube

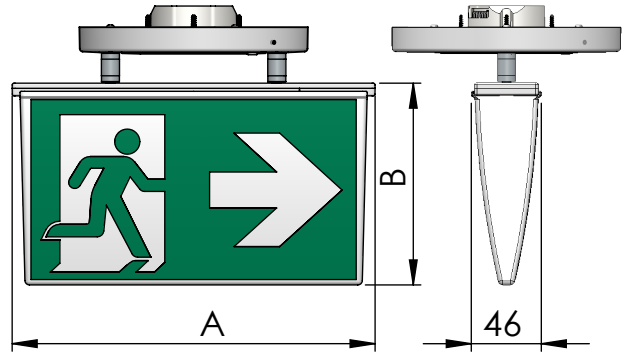

## Deckenverlängerung

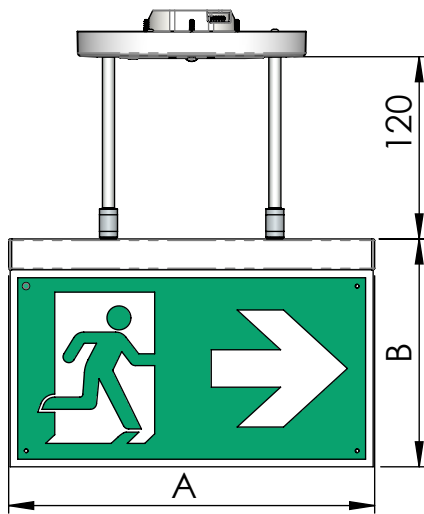

## Seilaufhängung

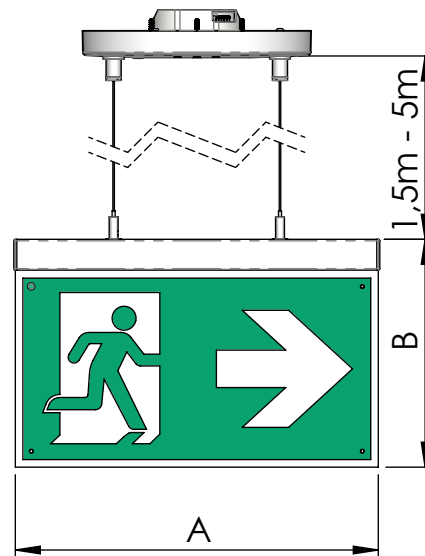

## RZ Leuchte Wand (nur TH6 + TH8)

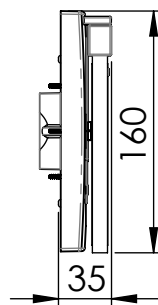
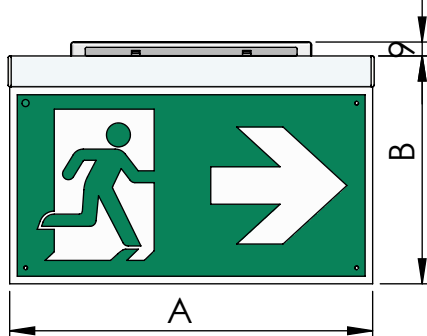

## Ausleger

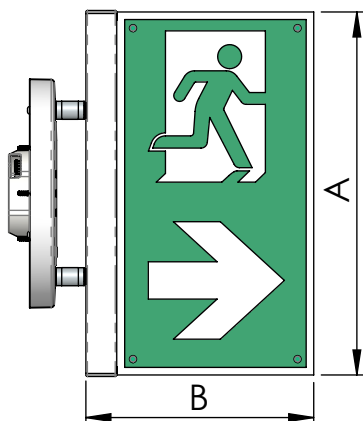

## Angaben in mm

	A	B
TH4	180	114
TH6	242	151
TH8	322	196
THH	240	133

Alle Varianten für Aufbau und Befestigung auf Geräte-Dose